

ESH

Capacity Chart ESH

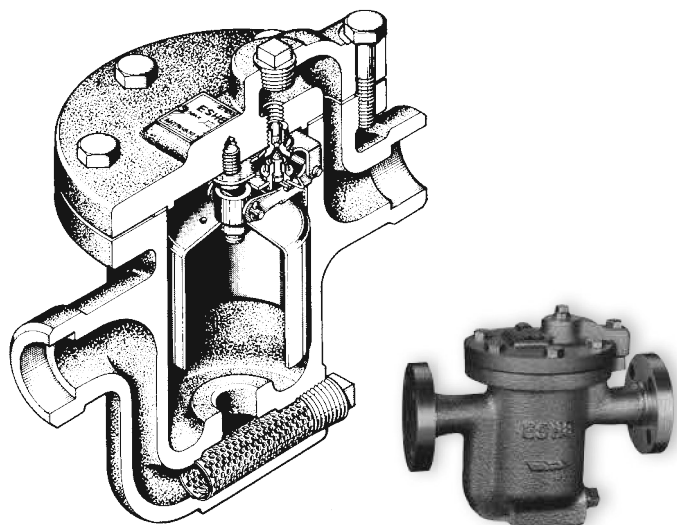
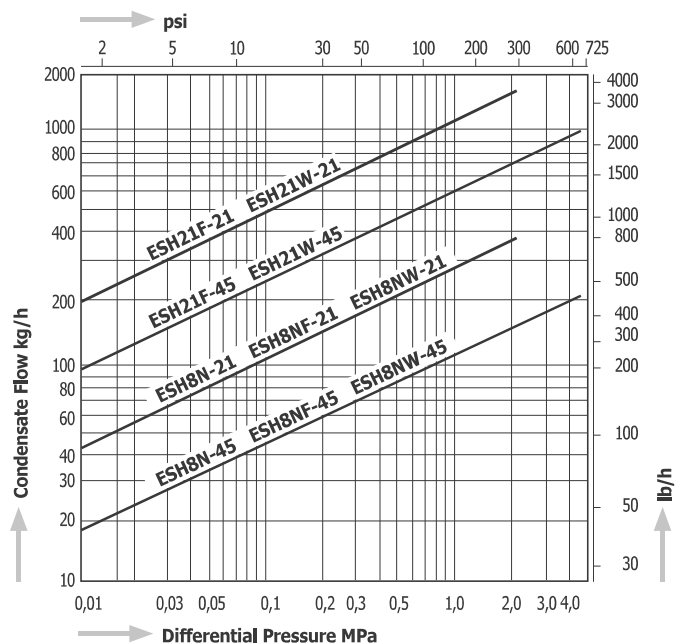

Dimensions

ESH8N, ESH8NW

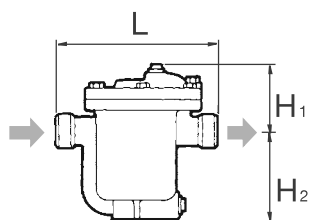

ESH8NF

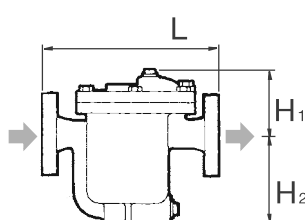

ESH21W

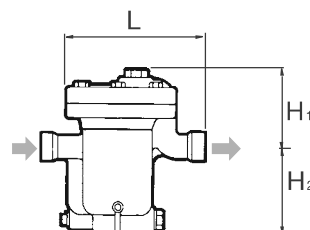

ESH21F

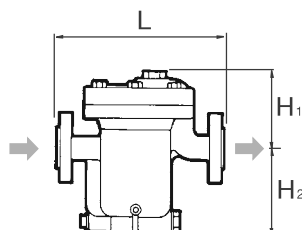

All models

Screwed, Socket Weld

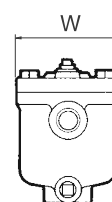

Flanged

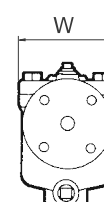

Model	Connections	Size	Max. Operating Pressure		Max. Operating Temperature		Dimensions (mm)				Dimensions (in)				Body Material	Weight	
			MPa	psig	°C	°F	L	H1	H2	W	L	H1	H2	W		kg	lb
ESH8N - 21 45	Screwed Rc, NPT	1/2" - 1"	2,1	305	400	752	1/2" - 3/4" = 220 1" = 224	114	111	146	1/2" - 3/4" = 8.7 1" = 8.8	4.5	4.4	5.7	Cast Steel SCPH2	11,0	24.2
			4,4	640													
ESH8NF - 21 45	Flanged JIS, ASME, DIN	1/2" - 1"	2,1	305			220	114	111	146	8.7	4.5	4.4	5.7		11,0	24.2
			4,4	640													
ESH8NW - 21 45	Socket Weld JIS, ASME, DIN	1/2" - 1"	2,1	305			350	145	160	205	13.8	5.7	6.3	8.1		31,0	68.2
			4,4	640													
ESH21F - 21 45	Flanged JIS, ASME, DIN	1/2" - 1"	2,1	305			300	145	160	205	11.8	5.7	6.3	8.1		28,0	61.6
			4,4	640													
ESH21W - 21 45	Socket Weld JIS, ASME, DIN	1/2" - 1"	2,1	305													
			4,4	640													